



*Section 22 Rehabilitation Alternatives
Analysis and Environmental Permitting
Quarterly Update*

April 14, 2021



Neponset River Crossing – Boston/Milton





Leak Detection Equipment

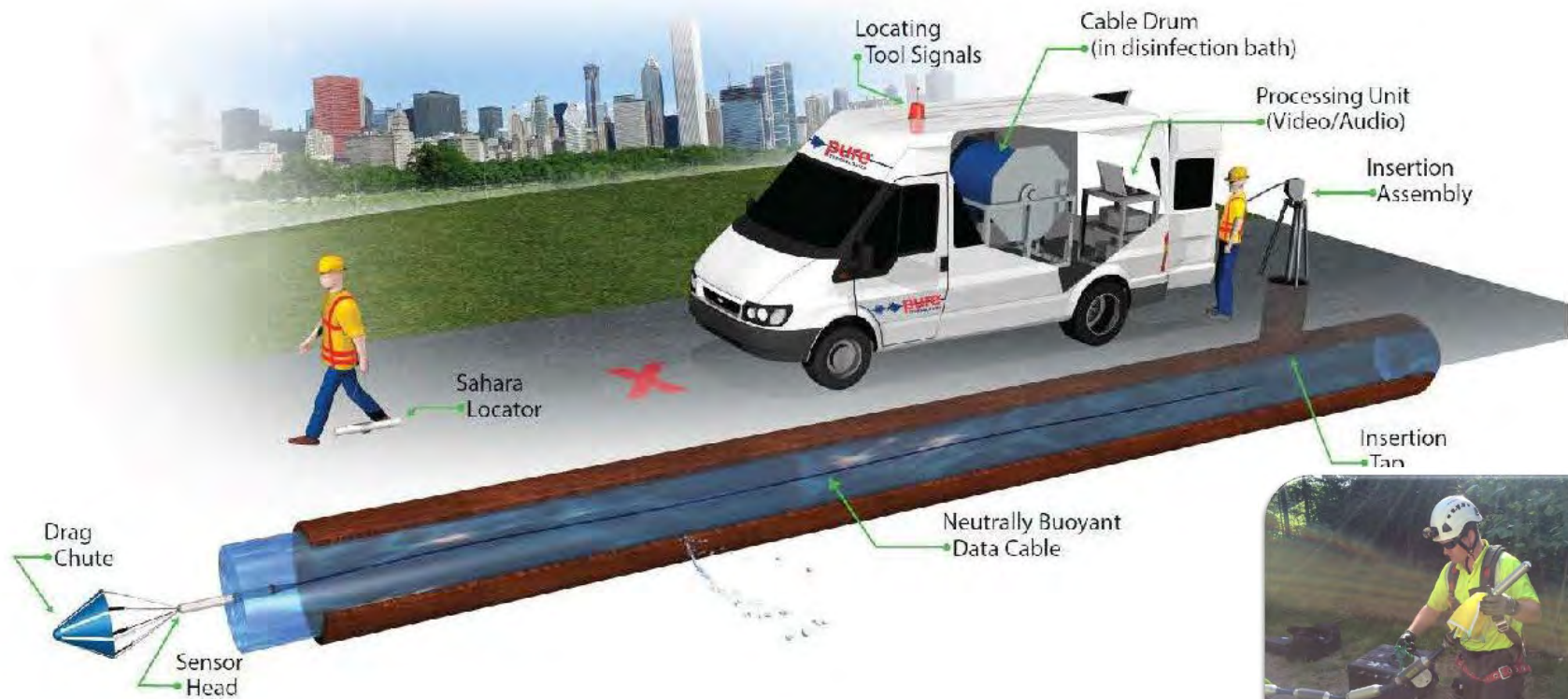



Project Schematic

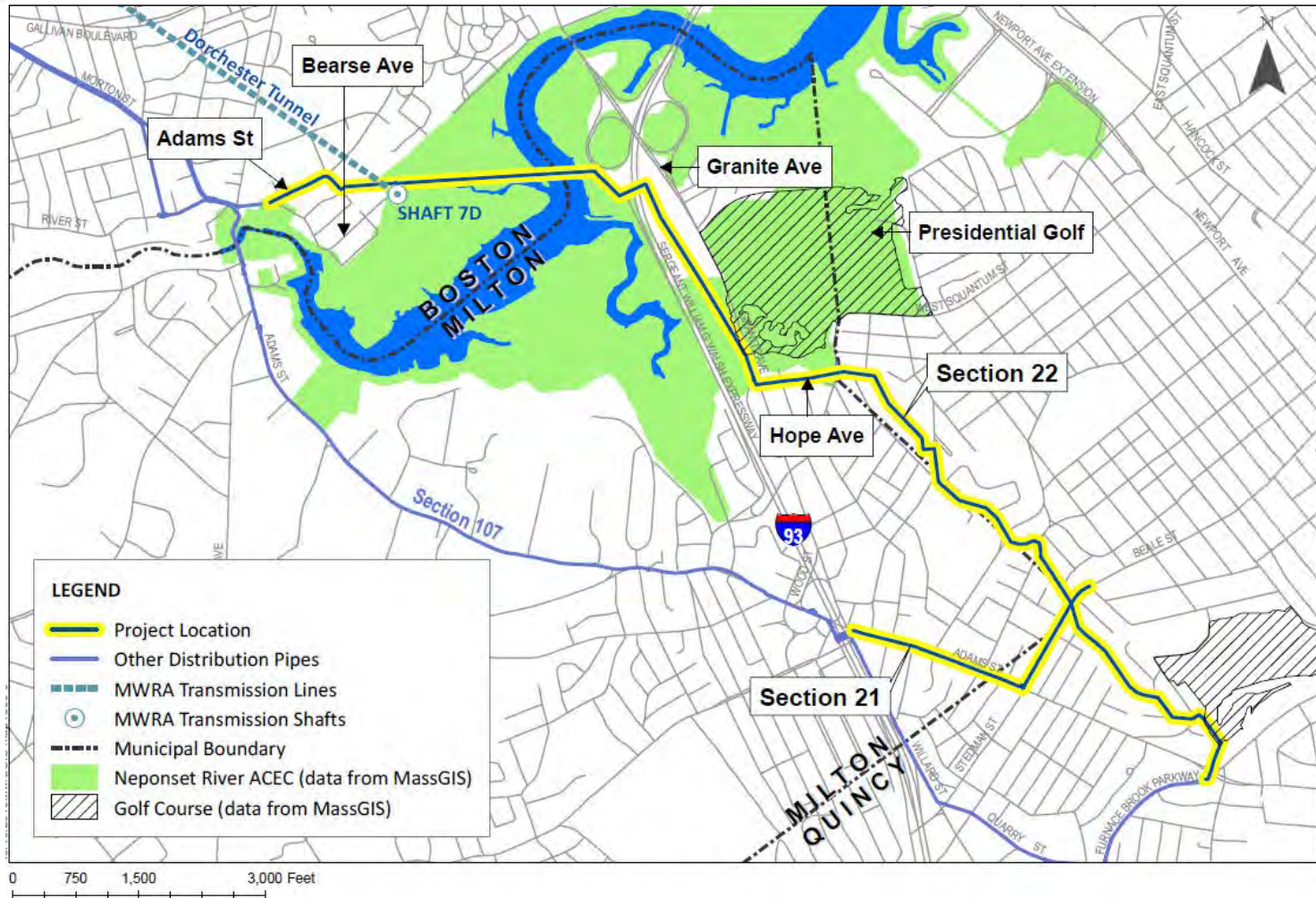



*Diver Assisted Suction Harvesting (DASH) of
Invasive Aquatic Plants at Wachusett Reservoir
Lower Basins and Coves*

Contract WRA-4942 Award

April 14, 2021



Wachusett Reservoir DASH Work Areas

- Aquatic invasive plant control work since 2002
- Reduction in effort required at Stillwater Basin
- Concentration on removal efforts at Quinapoxet Basin

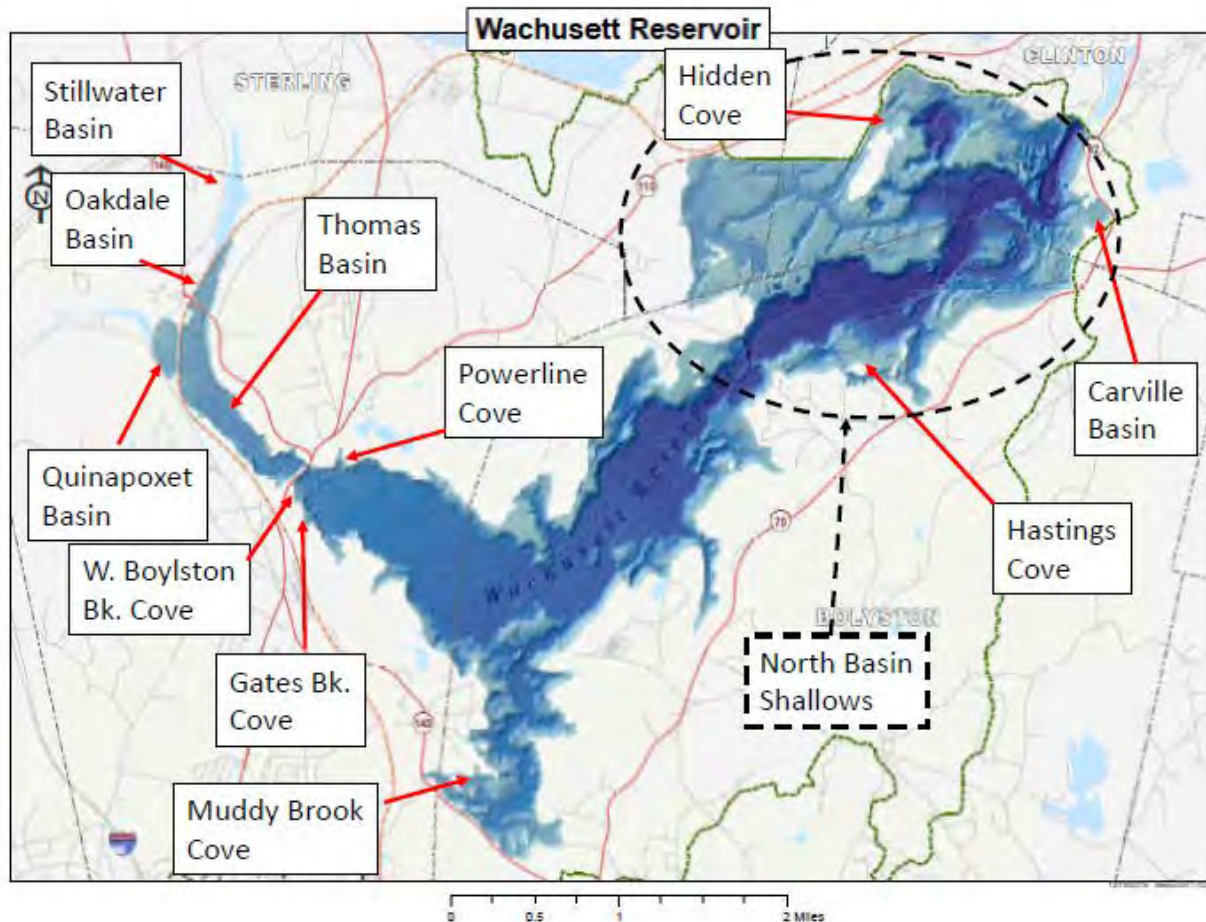



Stillwater Basin Eurasian Milfoil

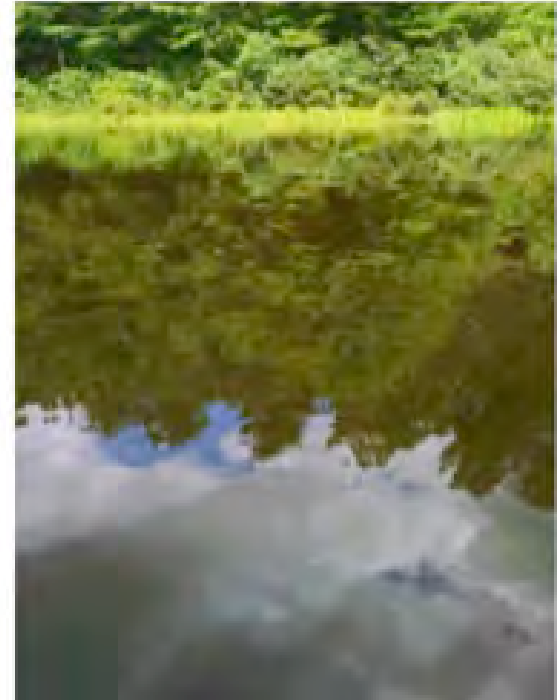
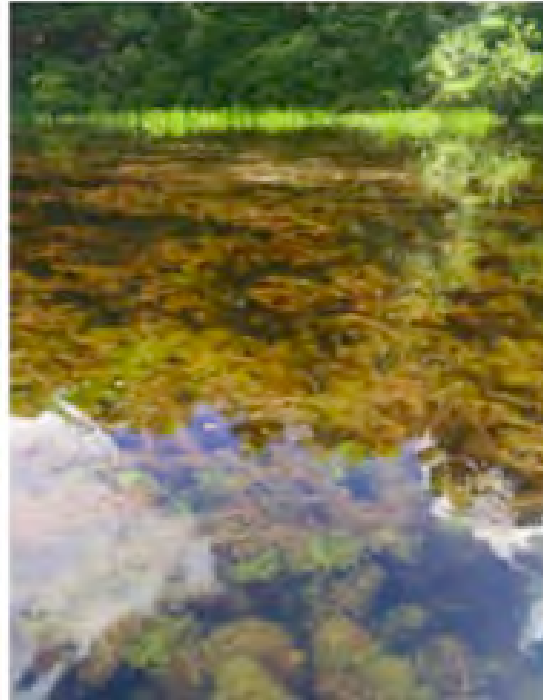

Former heavy removal area to be scaled back in 2021



Underwater Views - Before and After DASH





Quinapoxet Basin



Heavy Variable Leaf Milfoil

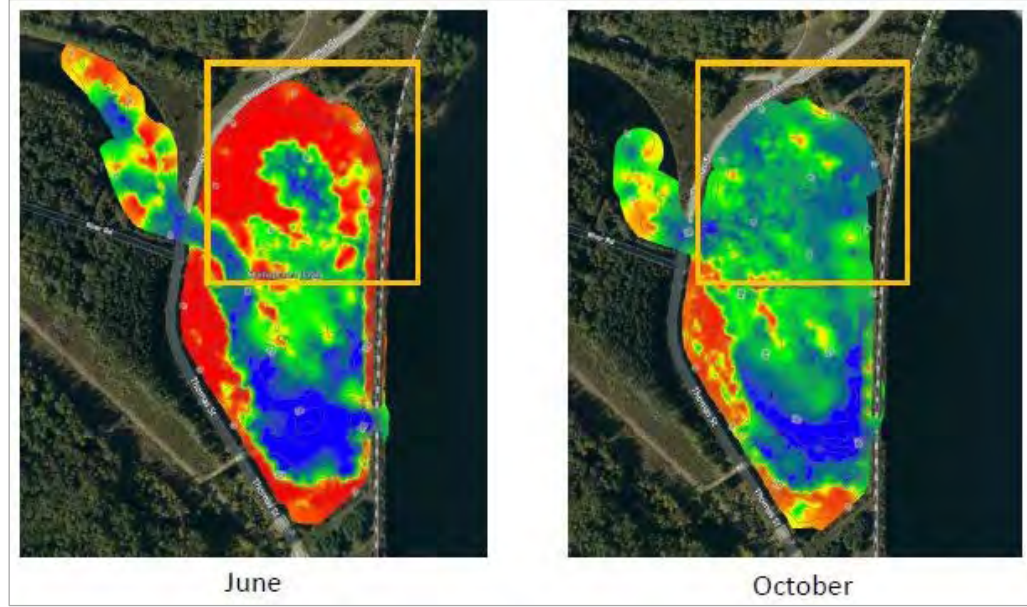

Before DASH June 2020 and October 2020



Community Leak Detection Survey Services : Arthur Pyburn & Sons, Inc. and Liston Utility Services

- Contract Awards
 - \$400,000 each
 - 3-year term
- Presenter:
 - Carl Leone



*Shaft 5 Building Improvements
Design/ESDC
Contract 7599*

April 14, 2021



Shaft 5 Site Location

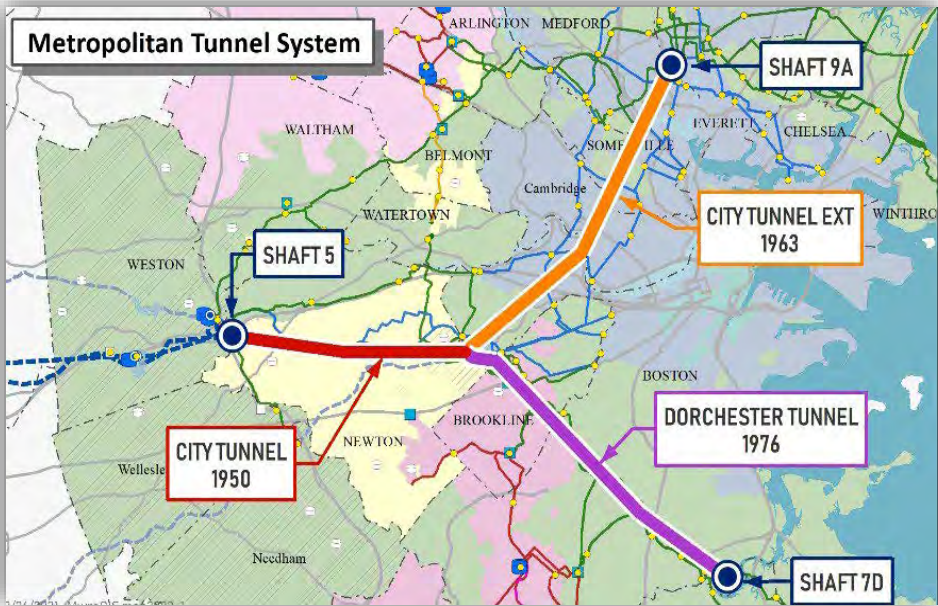

Shaft 5 Location



Shaft 5 Site



Shaft 5 Exterior



Shaft 5- West/ Rear View



Shaft 5 - Front View



Shaft 5 Interior



Electrical Switchgear



Procurement Process and Project Cost

Proposer	Rank	Cost	Hours
Kleinfelder	1	\$1,158,678	7,124
Mott Mac Donald	2	\$1,308,443	7,317
<i>Engineer's Estimate</i>		<i>\$1,293,150</i>	<i>7,121</i>

- One step RFQ/P
- Selection Committee recommends award to Kleinfelder



*Section 89 Replacement Project
Resident Engineering Services
Contract 7633*

April 14, 2021



Northern Intermediate High Redundancy Loop

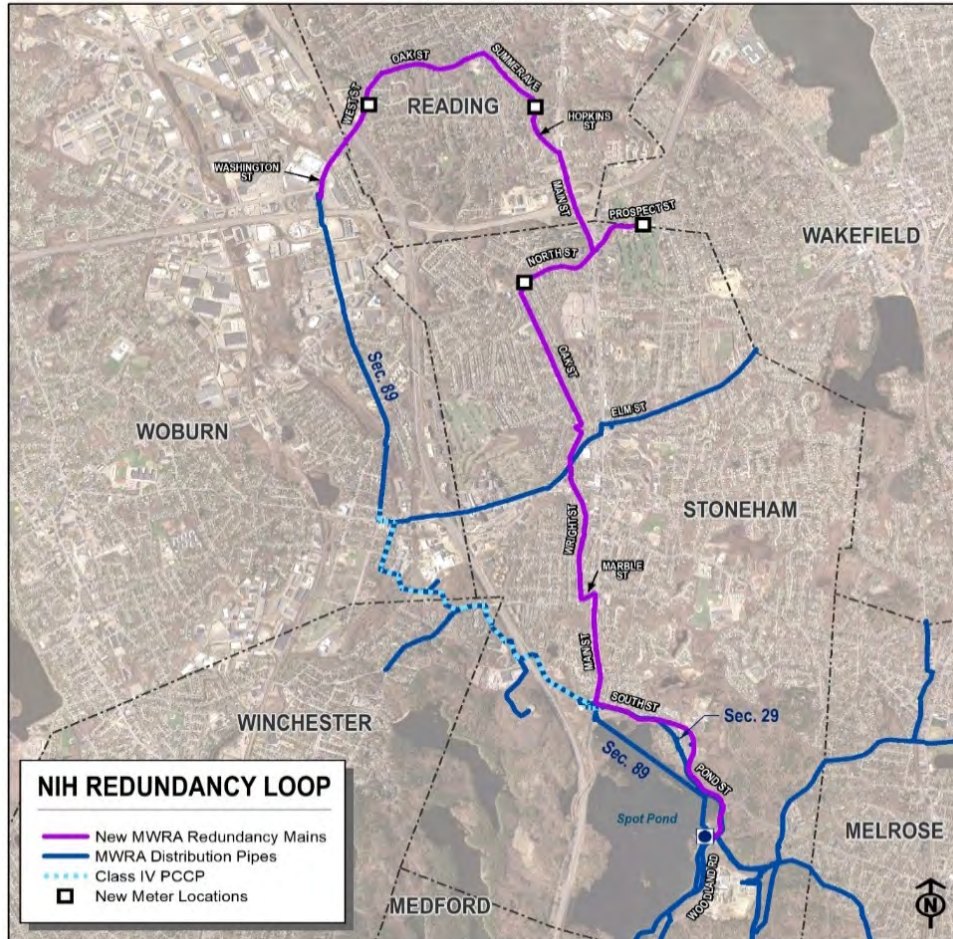

NIH included:

- 11,200 linear feet of 36-inch pipeline
- 21,800 linear feet of 48-inch pipeline
- 2,600 linear feet of 12 to 16-inch pipeline
- Four new Revenue Meters
- In Service December 2019



NIH Section 89 Replacement

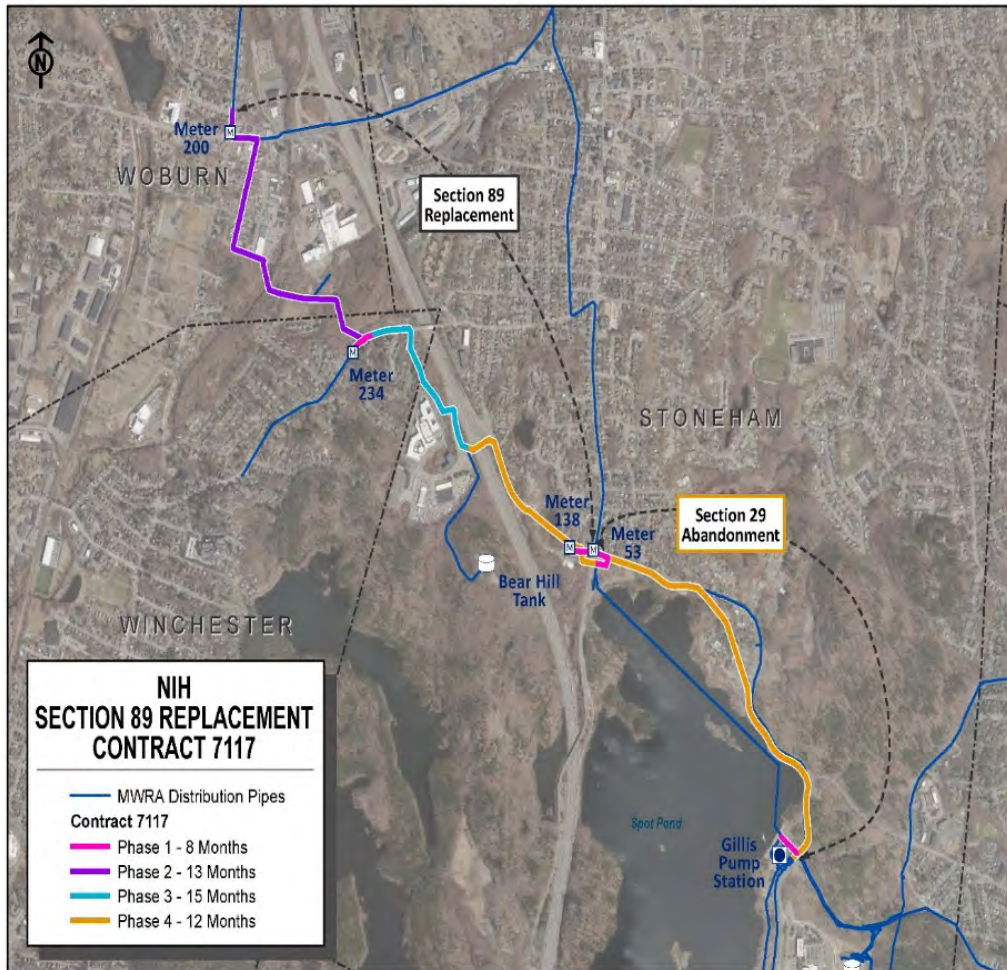

Construction Contract 7117

- 10,500 linear feet of 48-inch pipeline
- Abandonment of Section 29 (6,000 Linear feet of 24-inch diameter pipe)



Section 89 Resident Engineering Services

PROPOSER	CONTRACT COST	FINAL RANKING
Stantec Consulting Services, Inc.	\$1,697,990	1
CDM Smith Inc.	\$1,635,935	2
MWH Constructors Inc.	\$2,225,096	3
<i>Engineer's Estimate</i>	<i>\$2,120,720</i>	



Section 89 Replacement Project, ESDC: Stantec Consulting Services Inc., Contract 7116, Amendment 1

- Contract Amendment
 - \$443,100
 - 41-month extension
- Presenter:
 - Patrick Barrett, Program Manager
 - John Colbert, Chief Engineer



Appointment of Deputy Director of Waterworks

- For approval
- Presenter:
 - Andrea Murphy, Director of Human Resources



Occupational and Medical Services: AllOne Health Resources, Inc., Contract A628

- Contract Award
 - \$132,625.50
 - 3-year term
- Presenter:
 - Andrea Murphy, Director of Human Resources



*2020 Annual Update on New
Connections to the MWRA System*

April 14, 2021



MWRA Expansion Policies

- MWRA has five operating policies related to system expansion.
 - OP.04 - Sewer Connections Serving Property Partially Located in a Non-MWRA Community (Sewer Straddle Policy)
 - OP.05 - Emergency Water Supply Withdrawals
 - OP.09 - Water Connections Serving Property Partially Located in a Non-MWRA Community (Water Straddle Policy)
 - OP.10 - Admission of New Community to the MWRA Water System
 - OP.11 - Admission of New Community to MWRA Sewer System and Other Requests for Sewer Service to Locations Outside MWRA Sewer Service Area



New Water Connections Since 2002

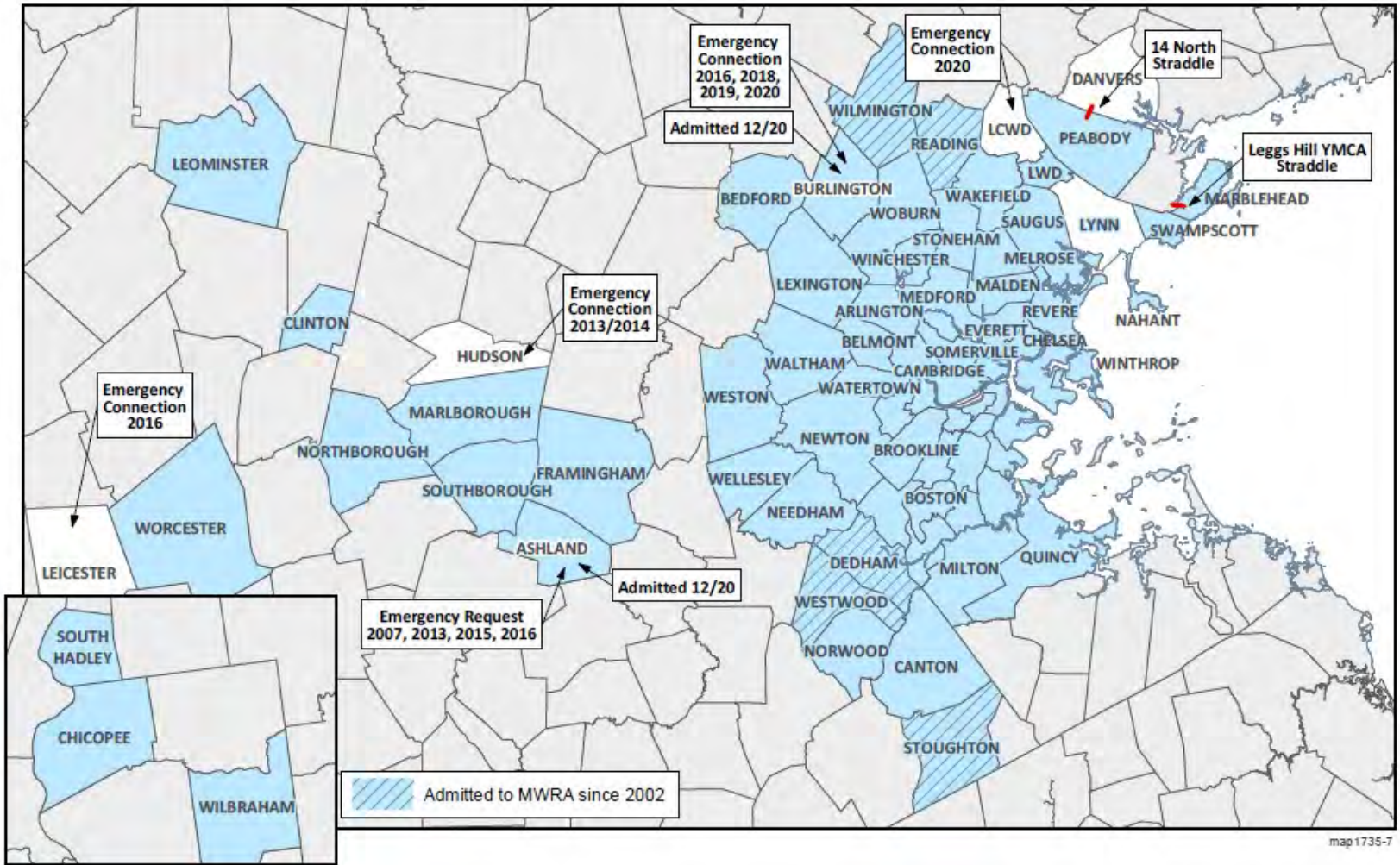



New or Increased Volume Sewer Connections Since 2002

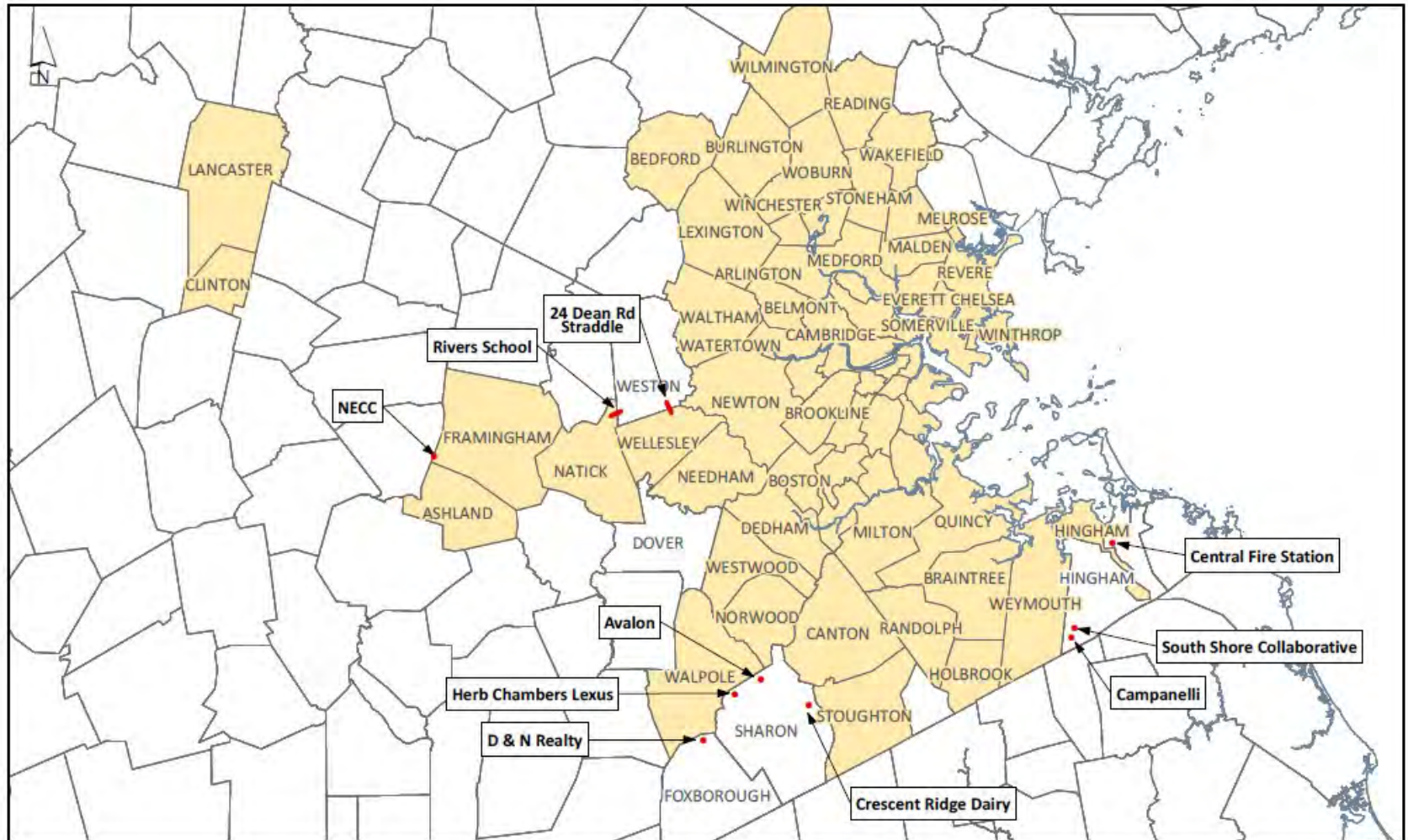



- For information only
- Presenters:
 - Michele Gillen, Director of Administration
 - Douglas Rice, Director of Procurement



FY21 Financial Update and Summary as of March 2021

- For information only
- Presenters:
 - Thomas Durkin, Director of Finance
 - Matthew Horan, Deputy Director of Finance
 - Michael Cole, Budget Director



*Assignment and Assumption of Contract 7347,
Quinapoxet Dam Removal, from Milone and
MacBroom, Inc. to SLR International Corp.*

April 14, 2021



Quinapoxet Dam at Oakdale, Shaft 1, Wachusett Reservoir





Task Order Appraisal Services: Foster Appraisal & Consulting Co, Inc., Contract 607TA

- Contract Award
 - \$100,000
 - 3-year term
- Presenter:
 - Lisa Grollman, Project Manager
 - Michele Gillen, Director of Administration



- Contract Awards
 - \$550,000 each
 - 3-year term
- Presenter:
 - Richard Geisler, Environmental Manager
 - Beth Card, Director of Environmental and Regulatory Affairs



Maintenance and Support of the Integrated Financial, Procurement and HR/Payroll Management System, Infor Inc.

- Contract Award
 - \$508,757.77
 - 1-year term
- Presenter:
 - Paula Weadick, Director of MIS



Telephone System Upgrade

- Voice Over IP Technology
- Integration with Webex Meetings and existing infrastructure
- Phone support for Teleworkers
- 5 years Maintenance
- 3 years Managed Services



Locations:

Charlestown Navy Yard - Chelsea Facility - Clinton Water Treatment Plant - Cosgrove Intake

Walpole Records Center - John J. Carroll Water Treatment Plant - Nut Island Headworks

Southborough Facility - Deer Island Treatment Plant - Pelletizing Plant



*Financial Assistance Agreement with
BWSC for Sewer Separation and Other
CSO Improvements in East Boston*

April 14, 2021



East Boston Sewer Separation and CSO Improvements

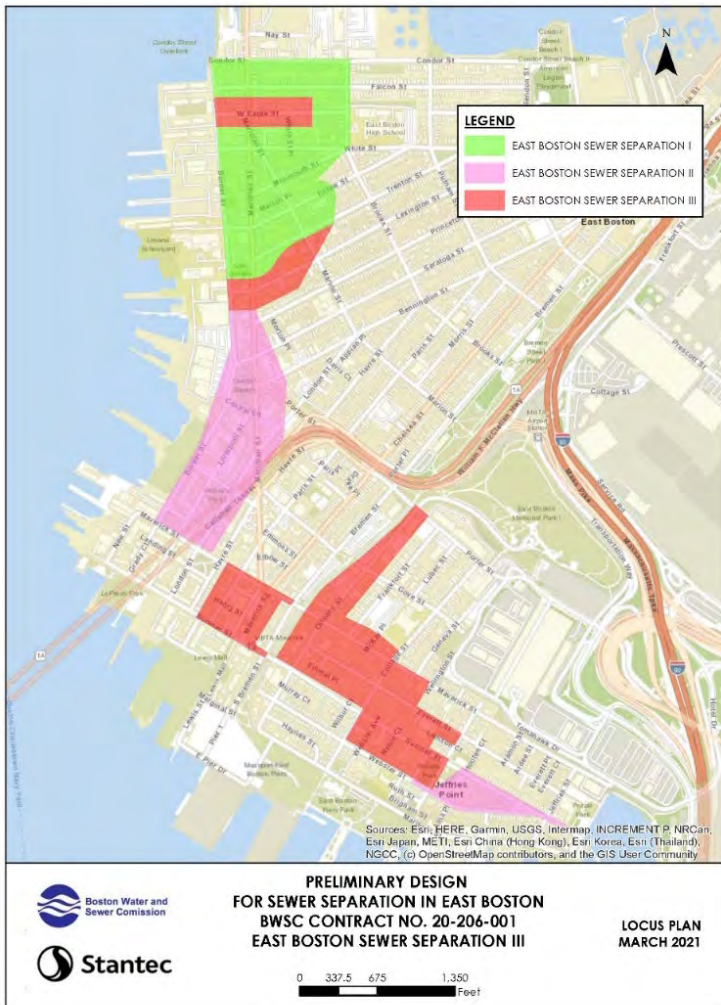

BWSC sewer separation and further CSO improvements predicted to meet long term CSO control plan goals after December 2021

Phase 1: Complete

Phase 2: In Construction

Phase 3: To Begin this Summer

Proposed transfer of remaining CSO program funds (\$2,181,667) to BWSC for eligible work



*South System Pump Station Improvements
Deer Island Treatment Plant
Contract 7126*

April 14, 2021



South System Pump Station Improvements



South System Pump Station

In Operation Since 1998

Receives flows from Nut Island Headworks –
MWRA's 20 Southern Communities

400 MGD capacity, 110 MGD Average Design Flow
8-66.7 MGD Pumps

Contract 7126

Design and Construction Oversight contract:

- Duration - 80 months
- Design (preliminary and final)
- Engineering Services During Construction
- Resident Engineering/Inspection Services



Major Upgrades

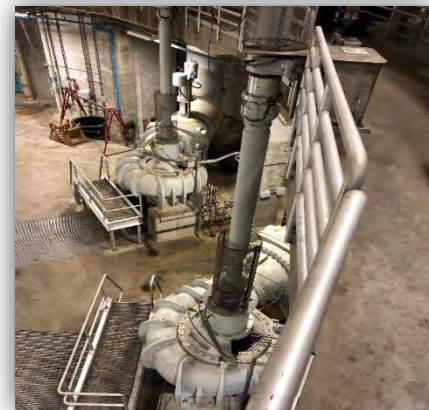



Engineer's Estimate Issues

- Based upon historical data for simple direct replacement project
 - Project is significant redesign of the existing piping and isolation of the pumps
- Under-estimated the hours per drawing
- Under-estimated hours for technical studies:
 - Hydraulics, pump efficiency and VFD technology assessments
- Under-estimated hours for the ESDC
- 3D model level of effort was not included in Engineer's estimate



Procurement Process and Project Cost

- One step RFQ/P
- Selection Committee recommends award to Hazen & Sawyer, PC

Proposer	Rank	Cost	Hours
Hazen & Sawyer, PC.	1	\$7,535,701.14	44,325
AECOM	2	\$8,297,068.70	49,869
Brown & Caldwell	3	\$4,924,513.99	29,923
Engineer's Estimate		\$5,129,418.66	29,887



*Repair of Three Digester Mixer
Assemblies at Deer Island*

April 14, 2021



Egg-Shaped Digesters and Mixer System

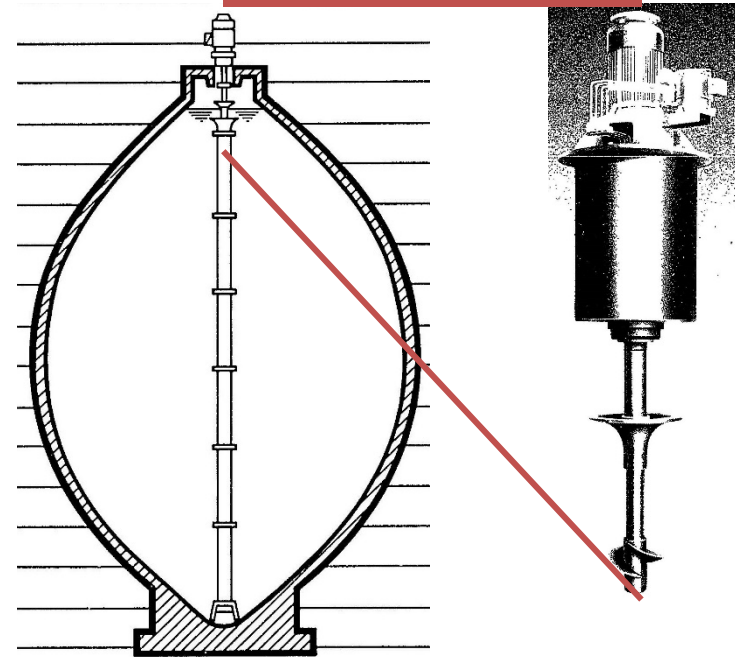

TYPICAL MIXER INSTALLATION



Mixer Assembly Before and After Refurbishment



